



BOLTON

F U R N I T U R E

133 Gallery Lane, Morrisville, VT 05661

(802) 888-7974 Fax (802) 888-3668

boltonfurniture.biz



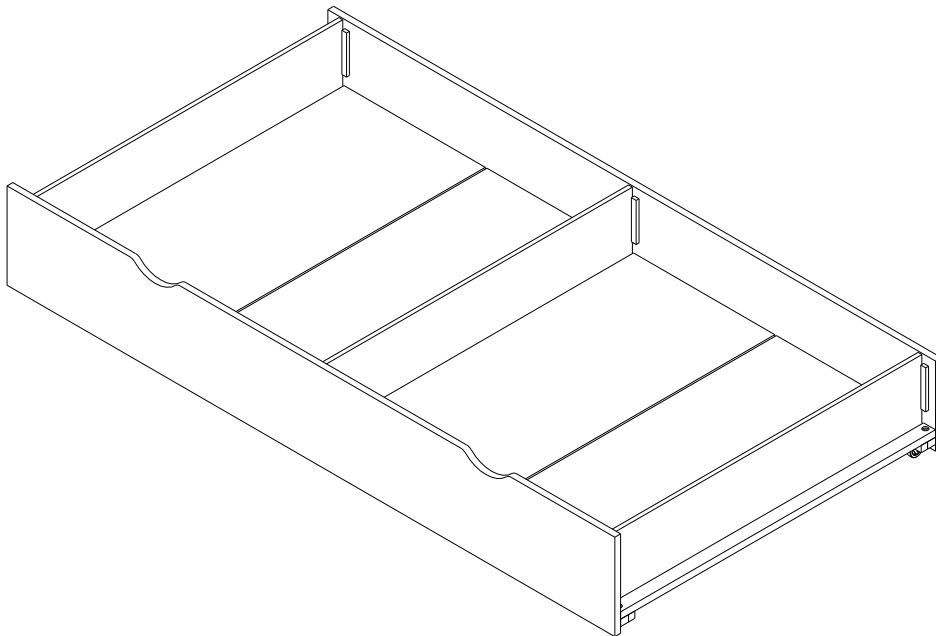



Trundle Bed







Thank you for purchasing our Trundle Bed.

We have found it helpful to have a second person present in at least one step of the assembly.

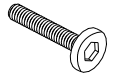
Lay out parts on a non-abrasive surface to avoid scratching finish.

NO.	DRAWING	DESCRIPTION	Q'TY
A		FRONT PANEL	1
B		BACK PANEL	1
C		SLATS(1)	3
D		SLATS(2)	2
E		SIDE PANELS	3
F		BOTTOM PANELS	4

NO.	DRAWING	DESCRIPTION	Q'TY
G		35MM HEX BOLT	12
H		30MM WOOD SCREW	4
I		WHEEL	6
J		15MM WOOD SCREW	12
K		HEX WRENCH	1

STEP 1

Identify and count all parts using diagram above. Wooden pieces should be placed on a non-abrasive surface (like the carton or carpet) to prevent damage to the finish.

STEP 2

Identify and count hardware using box above.

STEP 3

On Underside of Front Panel (A) and Back Panel (B).

Attach Wheel (I) to Front Panel (A) and Back Panel (B) with 12 15mm Wood Screws (J).

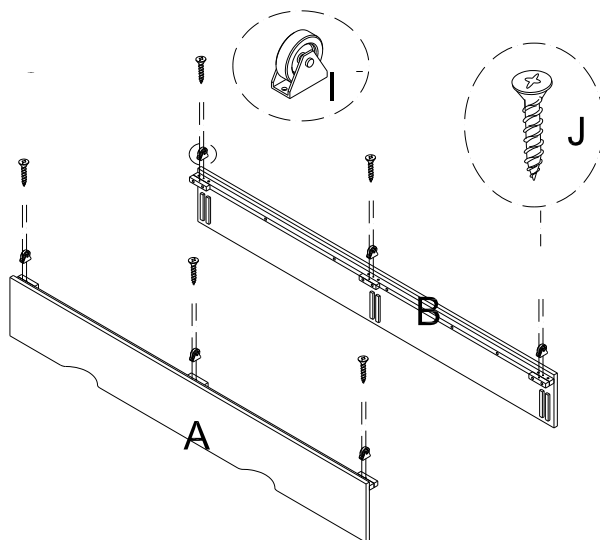

STEP 4 and 5

With Front Panel (A) and Back Panel (B) standing up and wheels on ground.

Attach 3 Slats with center groove (C) with 12 35mm Hex Bolts.

Attach 2 Slats with no groove (D) with 4 30mm Wood Screws (H).

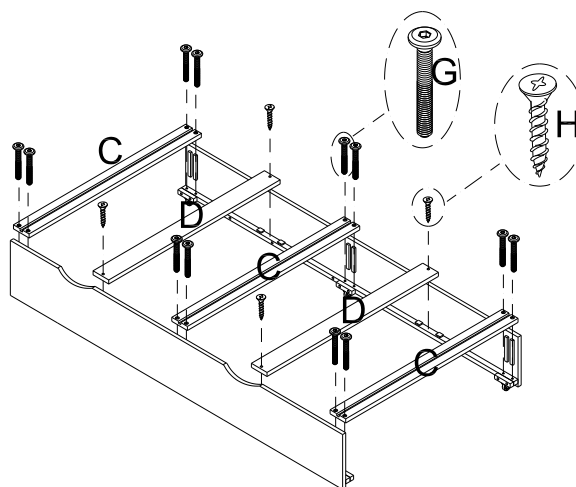

STEP 5

Place 3 Side Panels (E) into slots in Front and Back Panel (A) and (B) and into slots into Slats with Groove (C).

Place 4 Bottom Panels (F) on top of slats between Side Panels (E).

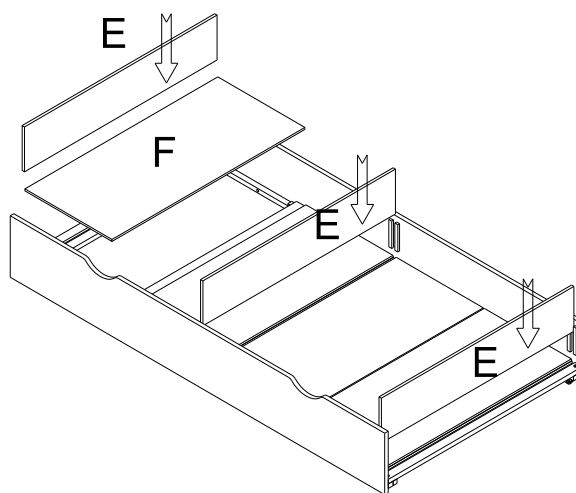

CARE: Clean with mild soap and wipe dry.