







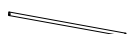

Assembly Sheet **Top Tent Frame - Top Tent**

Replacement parts can be obtained from any Bolton Furniture authorized dealer

PARTS LIST

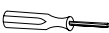
NO.	Drawing	Description	Qty.
A		Top Rail	2
B		Posts	4
C		Round Rod	2
D		Round Dowel Rod	2

NO.	Drawing	Description	Qty.
E		80mm Hex Bolt	4
F		50mm Hex Bolt	2
G		30mm Wood Screw	2
H		M6 Hex Wrench	1
I		Top Tent	1
J		Top Tent End	2

Top Tent Frame Assembly: Two people recommended for this assembly.

Step 1

Complete Assembly of Low Loft

Step 2 -

Open boxes and verify that all parts are included.

Step 3 - Begin Assembly Top Frame

Insert Round Rod (C - with inserts) into sleeve w/o velcro on Top Tent Ends (J). Do this on both ends. SEE ILLUSTRATION.

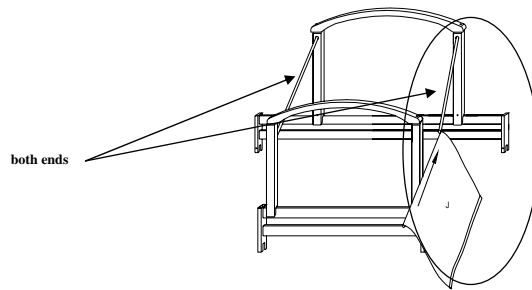

Insert Round Rods w/ Top Tent Ends into pre-drilled holes in Posts (B) 4 places. Make sure threaded insert are facing up aligned with hole in top edge of posts.

Step 4- Attach Top Tent Fabric

Attach Top Tent Fabric "I" to Front and Back Rails "A" in top frame assembly by sliding the rails thru the elastic bands.

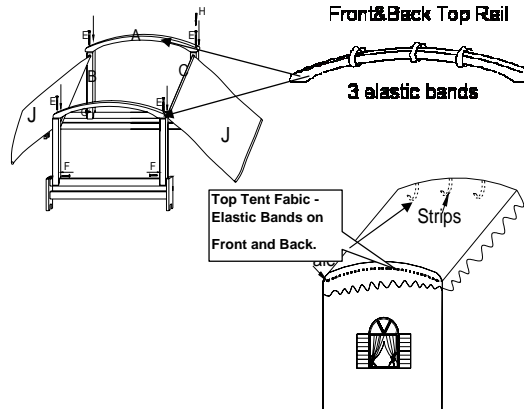

Step 5- Attach Top Rail w/Fabric to Post

Attach Top Rails (A) to top of posts by aligning pre-drilled thru holes to holes in top edge of post. Insert 80 MM Hex Bolt (E) into pre-drilled holes and thread into insert in Round Rod (C). Do this in 4 places. Tighten Hex Bolts using Hex Wrench (H)

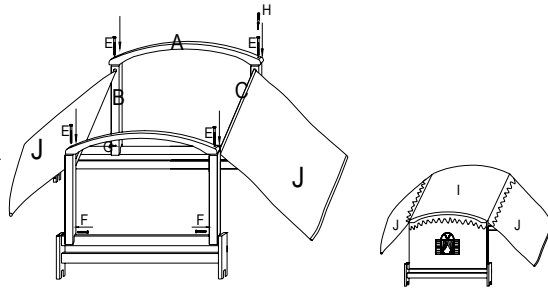

Step 6 - Attach Frame to front & Back Guardrail:

Position assembled top frame on front and back guardrails. Attach front two posts to short guardrail using 50 MM Hex Bolt (F). Tighten using Hex Wrench (H)

Center and make sure back post are aligned with post on front guardrail. Attach Back posts to long guardrail using 30 MM Wood Screws (G). Tighten w/ phillips screwdriver.

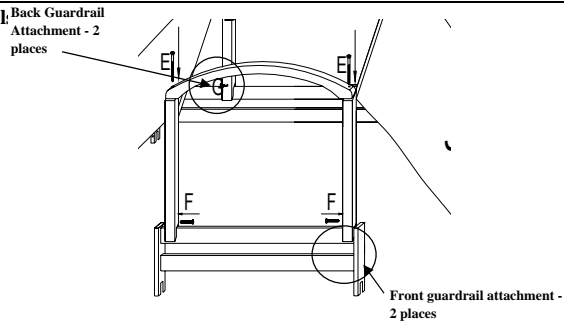

Step 7 - Insert Round Dowel Rod

Insert Round Dowel Rod (D) into the sleeve w/velcro on ends of Top Tent Ends (J). Lay the Top Tent Ends over bed ends.

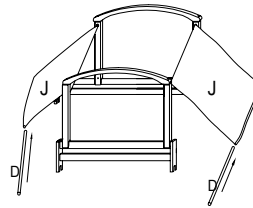

This completes the assembly of the Top Tent Frame and Top Tent Fabric!

