

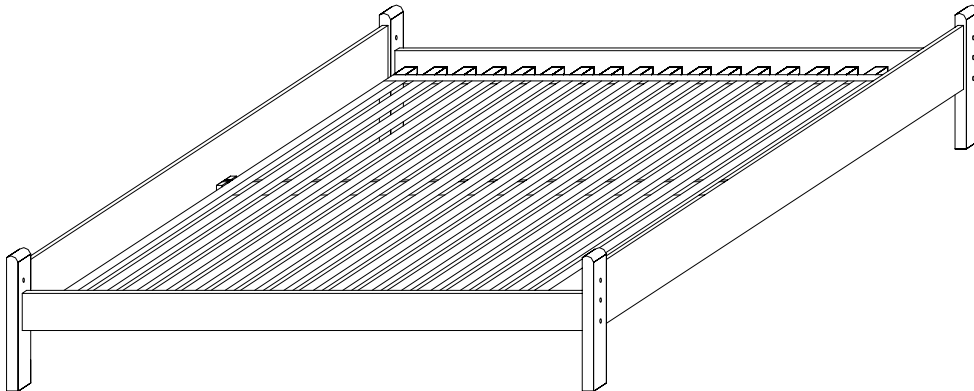

BOLTON
FURNITURE



Assembly Sheet
Platform Queen

Replacement parts can be obtained from any Bolton Furniture authorized dealer

249 Professional Drive, Morrisville, VT 05661

Ph: 802-888-7974

Fax: 802-888-3668

www.boltonfurniture.biz

PARTS LIST

NO.	Drawing	Description	Qty.
A		Bedends	2
B		Side Rails	2
C		Bed Slats	1
D		Center Support Rail	1
E		Center Support Leg-L	1
F		Center Support Leg-S	1
G		Wooden Brackets	2

NO.	Drawing	Description	Qty.
H		80mm Hex Bolt	9
I		Cross Dowel	9
J		Hex Wrench	1
K		30mm wood screw	30
L		Mushroom Plug	12
M		50mm wood screw	8

Platform Queen Assembly: Two people recommended for this assembly.

Step 1:

1) Verify that all parts are in box.

Step 2:

Position Bedends (A), and Side Rails (B) in approximate location where you want bed.

Rail (B). Make sure the slot for screwdriver is facing out and aligned to accept 80 MM Hex Bolt (H) - 8 places.

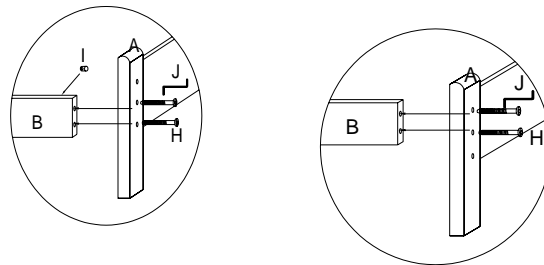

Attach Side Rail (B) to Bedends (A) by inserting Connector Bolts (H) thru pre-drilled holes in Bedends. Align the Connector Bolt to the predrilled holes in edge of siderails, into the connector bolts. When bed assembly is complete, tighten Connector Bolts with Hex Wrench (H)

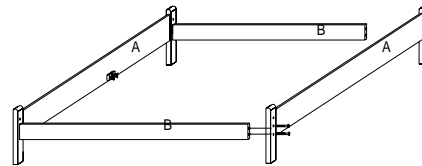

Step 3:

Determine if side rails are in upper or lower position.
Attach Wooden Bracket (G) to Bed ends using 50MM
Wood Screw (M). Screw on tight using phillips
Screwdriver.

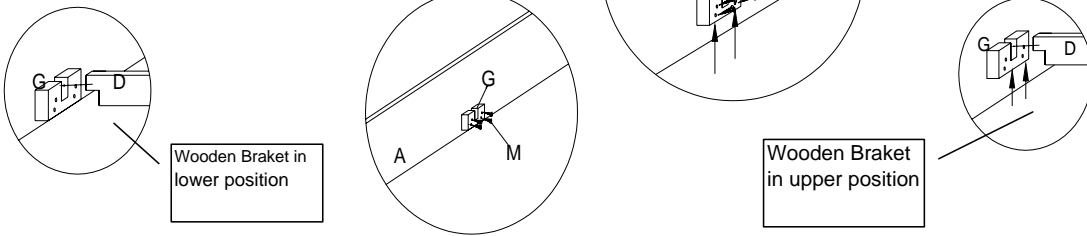

Step 4:

Attach Center Support Rail (D) to Wooden Brackets (G) using 30MM Wood Screws (K).

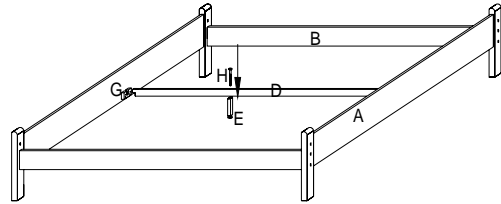

Attach Center Leg (E) or (F), depending on position
of side rails and Wooden Bracket (G).

Support Leg (E) for upper position.

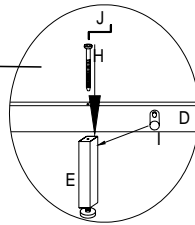

Support Leg (F) for lower position.

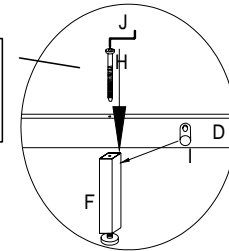

Step 5:

Attach Bed Slats (C) using 30 MM Wood Screw (K).
Screw in tight using Phillips Screwdriver.

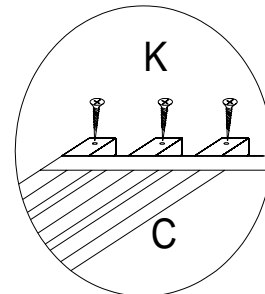
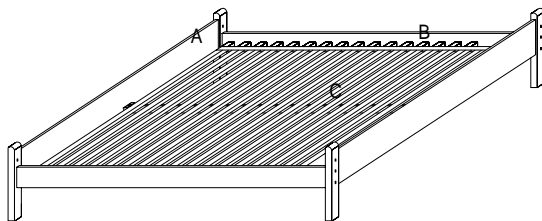

Step 6

Insert Mushroom Plug (L) into counter sunk holes in post of Bedends - 12 places.

