









## Modi Plate / Metal Bed Frame Assembly

### PARTS LIST

NO.	Drawing	Description	Qty.
A		Modi Plates	2
B		62mm Bed Bolts	4
C		13mm Bed Bolts	4
D		Cap Nuts	8
E		Hex Wrench	1
F		Washers	16

Replacement parts can be obtained from any Bolton Furniture authorized dealer

---

**Note: We cannot control the orientation or location of holes in all Metal Bed Frames. Our Modi Plate may not work with your particular Bed Frame. You may need to adjust the orientation of our Modi Plate or use a different attachment system depending on your particular Bed Frame.**

249 Professional Drive, Morrisville, VT 05661

Ph: 802-888-7974 Fax: 802-888-3668

[www.boltonfurniture.biz](http://www.boltonfurniture.biz)

**Step 1:**

1) Verify that all parts are in box.

---

**Step 2:**

Attach Modi Plate (A) to Head Board Bed Post using Bed Bolts (B), Washers (F) and Cap Nuts (D) - **See Illustration.** Do not tighten at this time. Attach Modi Plates to both bed post.

**NOTE:** May need to change orientation of Modi Plate depending on your Bed Frame.

Attachment of Modi Plate to bed/ Headboard

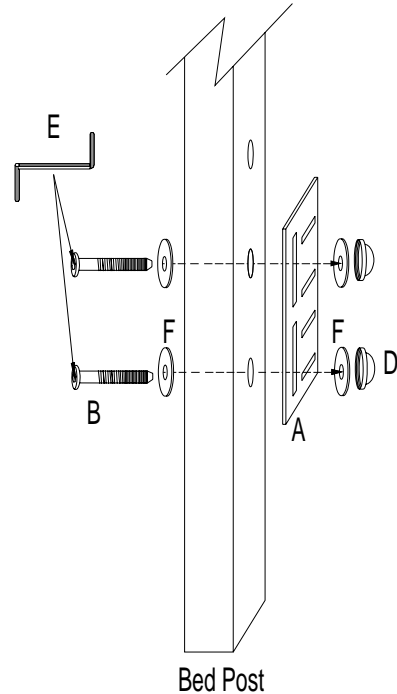

---

**Step 3:**

Attach your Metal Frame to Modi Plate using Bed Bolts (C), Washers (F) and Cap Nuts (D) - **See Illustration Below.** Attach to Both Bed Post. Adjust the Modi Plate up or down and Left or Right until slots in Modi Plate line up with holes/slots in Metal Bed Frame - **See Illustration on Right.**

Attachment of Modi Plate to Metal Bed Frame

