







**Assembly Sheet  
Mission Desk Hutch**

**249 Professional Drive  
Morrisville, VT 05661**

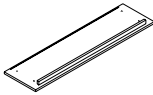
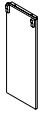
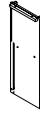
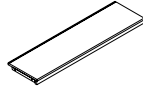
**Tel: 802-888-7974**

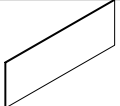
**Fax: 802-888-3668**

**Website: [www.boltonfurniture.biz](http://www.boltonfurniture.biz)**

NO.	DRAWING	DESCRIPTION	Q'TY
A		TOP PANEL	1
B		LEFT SIDE PANEL	1
C		RIGHT SIDE PANEL	1
D		SHELF	1
E		BACK BOTTOM RAIL	1
F		UPPER BACK PANEL	1
G		LOWER BACK PANEL	1
H		HEX BOLT	10
I		WOOD DOWEL	4
J		HEX WRENCH	1

---

### Step 1

Lay out and Identify all parts

---

### Step 2

Position right side panel (C) on a clean non abrasive surface with threaded inserts and grooves facing up. Insert Wood Dowels (I) into edge of Back Bottom Rail (E). Align thru holes in cleats on Shelf (D) and Back Bottom Rail (E) to inserts in Right Side. Secure Shelf and Back Bottom Rail to Right Side using Hex Bolt (H). Tightened Hex Bolt (H) using Hex Wrench (J).

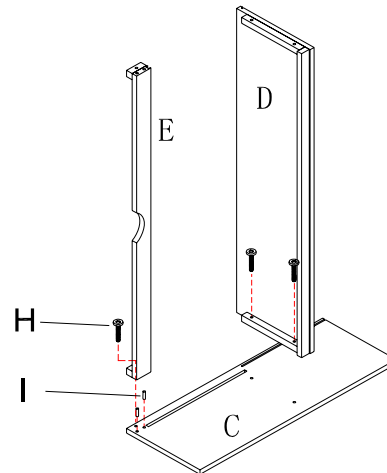

### Step 3

Slide Lower Back Panel (G) into groove on bottom side of Center Shelf and top edge of Back Bottom Rail. Position Upper Back Panel (F) into groove on top side of Center Shelf. Make sure that both Back Panels are seated in firmly. **Note: The bottom back panel has the cork board.**

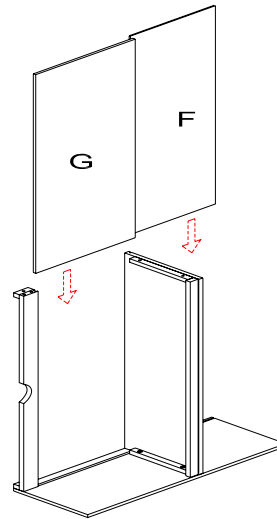

---

### Step 4

Attach Left Side Panel (B) by aligning thru holes in cleat of Center Shelf and Back Bottom Rail to inserts in Left Side Panel. Seat the side down firmly. Thread Hex Bolt (H) into threaded inserts in Left Side. Tighten Bolts using Hex Wrench (J).

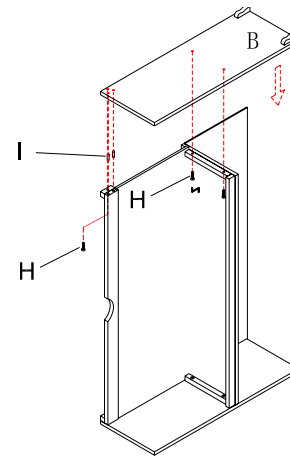

---

### Step 5

Attach Top Panel (A) by aligning thru holes in cleats on the left and right side panels to inserts in underside of Top. Secure top to sides using Hex Bolts (H). Tighten hex bolts using Hex Wrench (J).

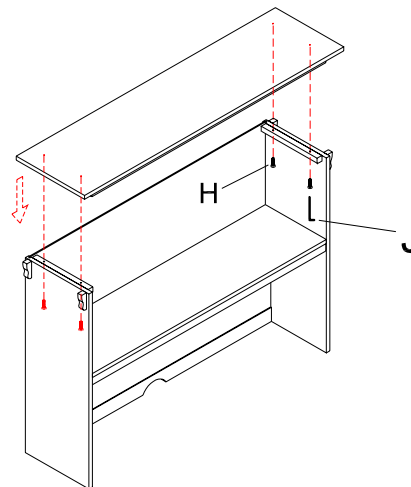

---

Replacement parts may be obtained from any authorized Bolton Furniture dealer.