

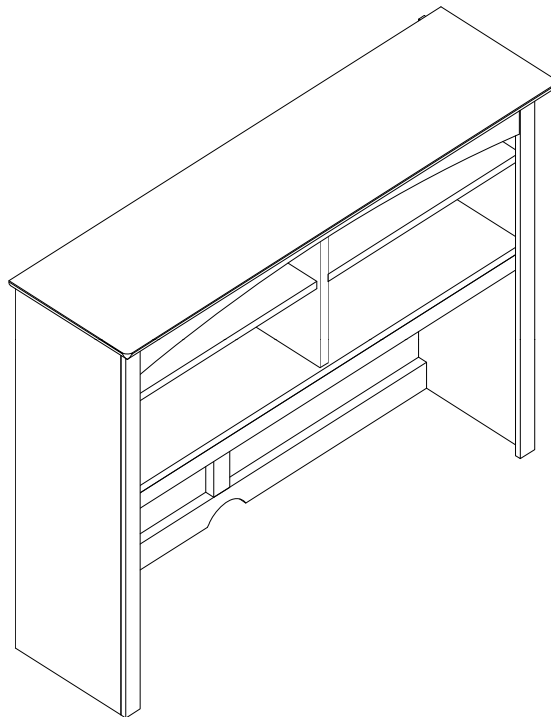

BOLTON
FURNITURE











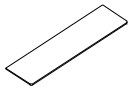
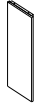

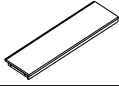

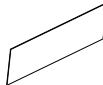



Assembly Sheet

Essex Desk Hutch

133 Gallery Lane

Fax: 802-888-3668

NO.	DRAWING	DESCRIPTION	QTY
A		TOP	1
B		LEFT SIDE PANEL	1
C		RIGHT SIDE PANEL	1
D		SHELF	1
E		HORIZONTAL SIDE SHELF	2
F		VERTICAL DIVIER	1
G		UPPER BACK PANEL	1
H		BACK RAIL	2
I		VERTICAL BACK RAIL	1
J		CORKBOARD	2

NO.	DRAWING	DESCRIPTION	Q'TY
K		35MM HEX BOLT	12
L		45MM HEX BOLT	2
M		WIRE GUIDE	6
N		WOOD DOWEL	12
O		WOOD SCREW	4
P		MENDING PLATE	2
Q		HEX WRENCH	1
R		ANTI-TIP	1

Step 1

Lay out and Identify all parts.

Step 2

Lay out all components for lower back assembly as shown on non-abrasive surface.

Insert 4 Wood Dowels (N) into Vertical Rail (I).

Attach Back Rails (H) to Vertical Rail (I) with 2 45mm Hex Bolt (L) using Hex Wrench (Q).

Insert 8 Wood Dowels (N) into ends of Horizontal Rails (H).

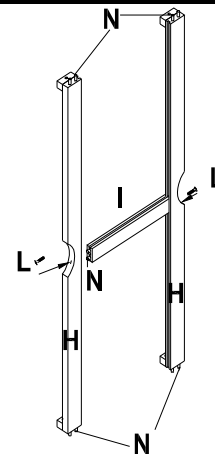

Step 3

Slide Corkboard (J) into upper and lower grooves of Horizontal Rails (H).

Position Right Side Panel (C) on a non-abrasive surface with threaded inserts and grooves facing up. Place Wooden Dowels (N) into holes in Right Side Panel (C).

Make sure that Corkboard (J) is facing the inside of Right Side Panel (C).

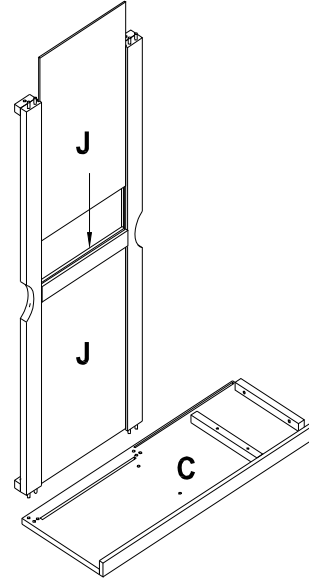

Step 4

Slide lower back assembly into place in groove in lower section of Right Side Panel (C). Attach Horizontal Rails (H) to Right Side Panel (C) with 2 35mm Hex Bolts (K) using Hex Wrench (Q).

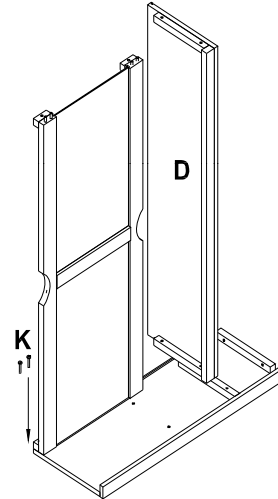

Step 5

Attach Shelf (D) to Right Side Panel (C) with 2 35mm Hex Bolts (K) using Hex Wrench (Q).

Set Back (G) into groove in Right Side Panel (C) and Shelf (D).

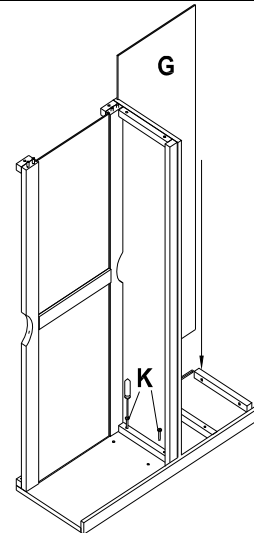

Step 6

Place Left Side Panel (B) on to hutch assembly lining up the Wooden Dowels (N) into correct holes.
Attach Left Side Panel (B) to Horizontal Rails (H) and Shelf with 4 35mm Hex Bolts (K) using Hex Wrench (Q).

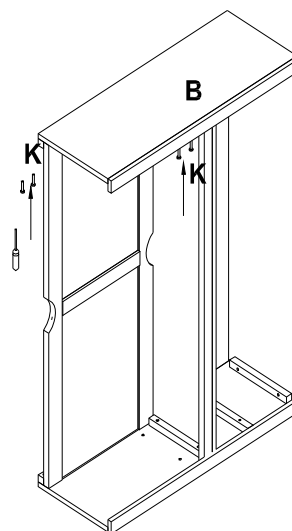

Step 7

Attach Top (A) to Left and Right Side Panels (B) + (C) with 4 35mm Hex Bolts (K) using Hex Wrench (Q).

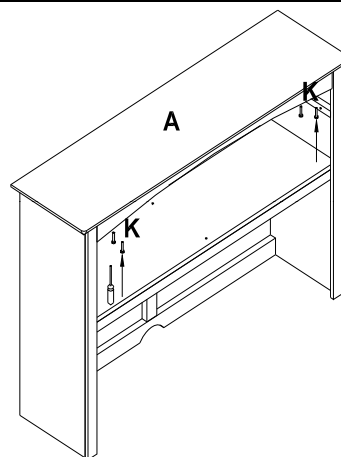

Step 8

Insert 6 Wire Guides (M) into underside of top, top of shelf and Side Panels.
Insert Vertical Divider (F) over Wire Guides (M), then insert Horizontal Side Shelves (E) over wire guides.

